

SOLUZIONE PER IL LAVAGGIO - LINEA RC
WASHING SOLUTION - RC SERIES

LAVATRICE RIGIDA RC 11 KG
HARD MOUNTED WASHING MACHINE RC11 KG

IM11 - UX e UI all'avanguardia
per una maggiore interazione uomo macchina.
Etichetta interattiva Tap.Tech.
IM11 - advanced UX and UI
for more human-machine interaction.
Tap.Tech. interactive label.

Carico acqua bilanciato
Carico acqua calda e fredda
bilanciato per il risparmio energetico.
Balanced water fill
Hot and cold water mixed during filling
phase for energy saving.

Sicurezza
Necessita di fissaggio a pavimento
(fischer non inclusi).
Security
Requires floor fixing
(fischer not included).



Gestione a 360°
Livello acqua, temperatura, velocità motore e
ritmo rotazione/pausa programmabili.
360° management
Programmable water, temperature, engine,
speed and rotation/break rate levels.

Nuovo oblò oversize,
il più grande della categoria,
per un carico e scarico più facile.
New oversized door,
the largest in its category,
for easier loading and unloading.

Acciaio INOX AISI 304 di SERIE
su cesto, stella cesto e vasca. Fronte, pannelli
laterali e top in acciaio INOX AISI 304 su richiesta.
STANDARD AISI 304 stainless steel
on drum, spider and outer drum. Front, top and
side panels in INOX 304 on request.



SCANSIONA PER ALTRE INFO
SCAN FOR MORE INFO



SCANSIONA PER ALTRE INFO
SCAN FOR MORE INFO

OPTIONAL e ACCESSORI / OPTIONS and ACCESSORIES

- Kit allacciamento fino a 11 pompe peristaltiche per detersivo liquido + Flush / Connection kit for up to 11 peristaltic pumps for liquid detergent + Flush
- Sistemi di dosaggio automatici detersigenti da 1 a 6 pompe peristaltiche / Automatic detergent dosing systems from 1 to 6 peristaltic pumps
- Kit pompa di scarico / Drain pump kit
- Kit 2 tubi di carico acqua in rete metallica da 3/4 inch / Kit of two pieces 3/4 inch metal mesh water load pipes
- Kit Fischer per fissaggio al suolo / Kit Fischer for ground fixing
- Fronte, top e pannelli laterali in INOX 18/10 AISI 304 / Front, top and side panels in 18/10 AISI 304 STAINLESS STEEL
- Apertura oblò sinistrorsa / Left-hand door opening
- Valvola ingresso acqua dura / Hard water inlet valve
- Seconda valvola di scarico per circuito di recupero / Second drain valve for recovery circuit
- IoT (connessione wi-fi) per controllo macchina da remoto / IoT (wi-fi connection) for remote machine control

DATI TECNICI / TECHNICAL DATA

RC 11

- Capacità 1:9 - 1:10 / Capacity 1:9 - 1:10	11,7 - 10,6 Kg (23.3 - 25.9 lb)
- Diametro cesto Ø / Drum diameter Ø	535 mm (21 inch.)
- Profondità cesto / Drum depth	470 mm (18.5 inch.)
- Volume cesto / Drum volume	105 lt
- Diametro di carico Ø / Load diameter Ø	380 mm (15 inch.)
- Velocità di centrifuga / Spin speed	535 r.p.m.
- Fattore G / G Factor	85
- Intensità sonora / Air sound intensity	65 dB (A)
- Perdite al mantello / Heating leakage	5 %
- Carico dinamico (frequenza) / Dynamic load (frequency)	2519 N (8.9 Hz)
- Consumo acqua fredda* / Cold water consumption*	68 l (2.4 ft³)
- Consumo acqua calda* / Hot water consumption*	20 l (0.7 ft³)
- Consumo acqua* / Water consumption*	88 l (3.1 ft³)
- Portata scarico / Drain flow	160 lt/min (5.6 ft³/min)
- Dimensioni macchina: LxPxH / Machine dimension WxDxH (100 mm = 3.93 inch.)	720x933x1087 mm
- Peso netto / Net weight	220,8 Kg (486.7 lb)
- Dimensioni imballo: LxPxH / Packing dimension WxDxH (100 mm = 3.93 inch.)	760x1045x1210 mm
- Peso lordo / Gross weight	231,5 Kg (510.3 lb)
- Peso lordo gabbia in legno / Gross weight wooden cage	244 Kg (537.9 lb)
- Volume imballo / Packaging volume	0,96 mc (33.9 ft³)
- Macchine imballate STD per container 20' / STD. packed machines in to 20' container	32 pz. sovrapposte/stackable
- Macchine imballate STD per container 40' - 40' H.C. / STD. packed machines in to 40' container 40' H.C.	68 pz. sovrapposte/stackable

DATI PER TIPOLOGIA DI RISCALDAMENTO / DATA BY TYPE OF HEATING

- Riscaldamento elettrico (macchine elettriche) / Electrical Heating (electric machines)	9 kW
- Consumo* (macchine elettriche) / Consumption* (electric machines)	1,5 kWh
- Assorbimento elettrico (macchine elettriche) / Electric absorption (50/60Hz) (electric machines)	10,5 kW
- 3ph400V-480V(+N) / 3ph230V / 1ph230V (macchine elettriche / electric machines)	16 / 25 / 42 A
- Consumo vapore* (macchine vapore) / Steam heating consumption* (steam machines)	0,2 Kg (0.4 lb)
- Consumo elettrico* (macchine hot-water - vapore) / Electric consumption* (hot-water-steam machines)	0,8 kWh
- Assorbimento elettrico (macchine hot-water - vapore) / Electric absorption (50/60Hz) (hot-water-steam machines)	1,5 kW
- 3ph400V-480V(+N) / 3ph230V / 1ph230V (macchine hot-water - vapore / hot-water-steam machines)	- / - / 3 A

* Lavaggio "Cotone" 60° C / Cycle "Cotton" 60° C - EN60456, tab. A2

Pos. 1 - Acqua fredda 3/4" - Press. 0,5 ÷ 10 bar \ Cold water 3/4" - Press. 0,5 ÷ 10 bar

Pos. 2 - Acqua calda 3/4" - Press. 0,5 ÷ 10 bar \ Hot water 3/4" - Press. 0,5 ÷ 10 bar

Pos. 3 - Entrata vapore 3/4" \ Steam inlet 3/4" Press. 0,3 ÷ 9 bar

Pos. 4 - Scarico acqua / Drain valve Ø 50 mm (2 inch.)

Pos. 5 - Sfiato / Air vent Ø 50 mm (2 inch.)

Pos. 6 - Secondo scarico acqua / Second drain valve (optional)

Pos. 7 - Alimentazione elettrica / Electrical power supply

Pos. 8 - Carico detersivi / Detergent load

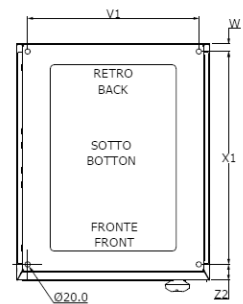
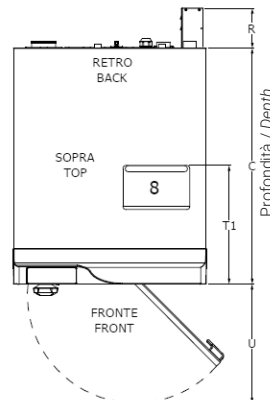
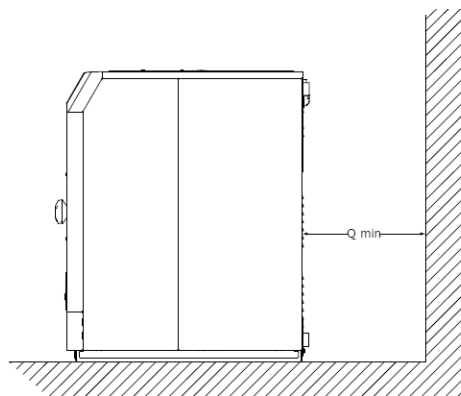

NO CONTROLAIO FISSAGGIO CON TASSELLI

NO FRAME FIXING WITH BOLTS

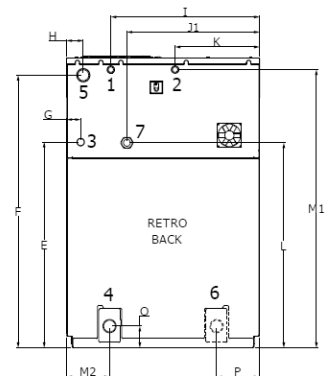
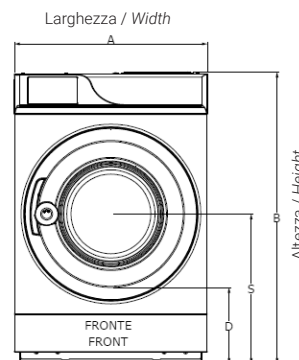

100 mm = 3.93 inch. - fattore di conversione 1 / 25,4 \ factor conversion 1 / 25,4

[mm]	A	B	C	D	E	F	G	H	I	J1	K	L	M1	M2	O	P	Q _{min}	R	S	T1	U	V1	W	X1	Z1	Z2
RC 11	720	1085	925	279	763	1013	52	62	555	315	495	760	1034	160	75	131,5	600	150	553,5	444	520	610	191	613,5	55	75



imesa.it

Via degli Olmi 22 31040 Cessalto TV Italia - info@imesa.it

IMESA
designing your clean

SOLUZIONE PER IL LAVAGGIO - LINEA RC
WASHING SOLUTION - RC SERIES

LAVATRICI RIGIDE RC 18 - 23 KG
LOW SPIN WASHING MACHINES RC 18 - 23 KG

IM11 - UX e UI all'avanguardia
per una maggiore interazione uomo macchina.
Etichetta interattiva Tap.Tech.
IM11 - advanced UX and UI
for more human-machine interaction.
Tap.Tech. interactive label.

Carico acqua bilanciato
Carico acqua calda e fredda bilanciato per il risparmio energetico.
Balanced water fill
Hot and cold water mixed during filling phase for energy saving.

Affidabilità e manovrabilità
Nuova chiusura oblò meccanica e nuova guarnizione conica.
Reliability and maneuverability
Mechanical door lock system and conical door gasket.

Sicurezza
Necessita di fissaggio a pavimento (fischer non inclusi).
Security
Requires floor fixing (fischer not included).

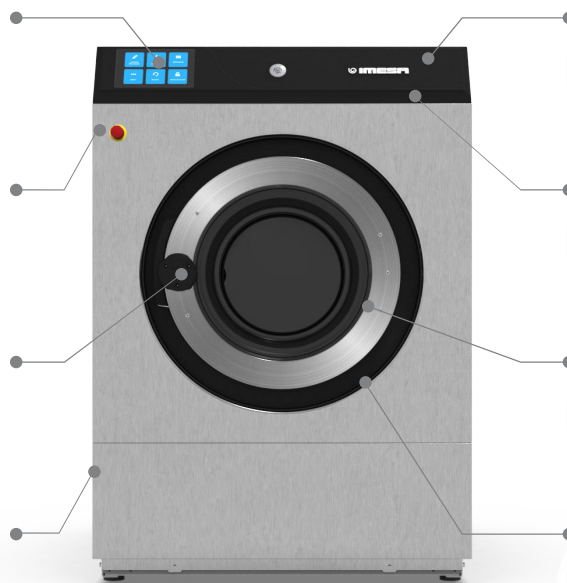

Gestione a 360°
Livello acqua, temperatura, velocità motore e ritmo rotazione/pausa programmabili.
360° management
Programmable water, temperature, engine speed and rotation/break rate levels.

Migliore ergonomia
Pannello comandi nero inclinato per una migliore visibilità.
Better ergonomics
Black control panel tilted for better visibility.

Acciaio INOX AISI 304 di SERIE
su cesto, stella cesto e vasca. Fronte, pannelli laterali e top in acciaio INOX AISI 304 su richiesta.
STANDARD AISI 304 stainless steel
on drum, spider and outer drum. Front, top and side panels in INOX 304 on request.

Migliore isolamento
Nuova contro-parete verniciata.
Better insulation
New painted counter-wall.



SCANSIONA PER ALTRE INFO
SCAN FOR MORE INFO



SCANSIONA PER ALTRE INFO
SCAN FOR MORE INFO

OPTIONAL e ACCESSORI / OPTIONS and ACCESSORIES

- Kit allacciamento fino a 11 pompe peristaltiche per detersivo liquido + Flush / Connection kit for up to 11 peristaltic pumps for liquid detergent + Flush
- Sistemi di dosaggio automatici detersivi da 1 a 6 pompe peristaltiche / Automatic detergent dosing systems from 1 to 6 peristaltic pumps
- Kit pompa di scarico / Drain pump kit
- Kit 2 tubi di carico acqua in rete metallica da 3/4 inch / Kit of two pieces 3/4 inch metal mesh water load pipes
- Kit Fischer per fissaggio al suolo / Kit Fischer for ground fixing
- Fronte, top e pannelli laterali in INOX 18/10 AISI 304 / Front, top and side panels in 18/10 AISI 304 STAINLESS STEEL
- Apertura oblò sinistrorsa / Left-hand door opening
- Valvola ingresso acqua dura / Hard water inlet valve
- Seconda valvola di scarico per circuito di recupero / Second drain valve for recovery circuit
- IoT (connessione wi-fi) per controllo macchina da remoto / IoT (wi-fi connection) for remote machine control

DATI TECNICI / TECHNICAL DATA		RC 18	RC 23
-------------------------------	--	-------	-------

- Capacità 1:9 - 1:10 / Capacity 1:9 - 1:10	20- 18 Kg (44 - 39 lb)	24 - 23 Kg (53 - 51 lb)
- Diametro cesto Ø / Drum diameter Ø	700 mm (27.5 inch.)	700 mm (27.5 inch.)
- Profondità cesto / Drum depth	470 mm (18.5 inch.)	560 mm (22.0 inch.)
- Volume cesto / Drum volume	180 lt	215 lt
- Diametro di carico Ø / Load diameter Ø	380 mm (14.9 inch.)	380 mm (14.9 inch.)
- Velocità di centrifuga / Spin speed	568 r.p.m.	568 r.p.m.
- Fattore G / G Factor	126	126
- Intensità sonora / Air sound intensity	65 dB (A)	65 dB (A)
- Perdite al mantello / Heating leakage	5 %	5 %
- Carico dinamico (frequenza) / Dynamic load (frequency)	3963 N (9.5 Hz)	3467 N (9.5 Hz)
- Consumo acqua fredda* / Cold water consumption*	119 l (4.2 ft³)	152 l (5.3 ft³)
- Consumo acqua calda* / Hot water consumption*	34 l (1.2 ft³)	44 l (1.5 ft³)
- Consumo acqua* / Water consumption*	153 l (5.4 ft³)	196 l (6.9 ft³)
- Portata scarico / Drain flow	160 lt/min (5.6 ft³/min)	160 lt/min (5.6 ft³/min)
- Dimensioni macchina: LxPxH / Machine dimension WxDxH (100 mm = 3.93 inch.)	880x1010x1312 mm	880x1100x1312 mm
- Peso netto / Net weight	304,5 Kg (671.3 lb)	315,6 Kg (695.7 lb)
- Dimensioni imballo : LxPxH / Packing dimension WxDxH** (100 mm = 3.93 inch.)	920x1150x1430 mm	920x1150x1430 mm
- Peso lordo / Gross weight	319,7 Kg (704.8 lb)	331 Kg (729,5 lb)
- Peso lordo gabbia in legno - cassa in legno / Gross weight wooden cage - wooden case	366-386 Kg (807-851 lb)	373-393 Kg (822-866 lb)
- Volume imballo / Packaging volume	1,5 mc (52.9 ft³)	1,5 mc (52.9 ft³)
- Macchine imballate STD per container 20' / STD. packed machines in to 20' container	12 pz.	12 pz.
- Macchine imballate STD per container 40' / STD. packed machines in to 40' container	26 pz.	26 pz.

DATI PER TIPOLOGIA DI RISCALDAMENTO / DATA BY TYPE OF HEATING		RC 18	RC 23
---	--	-------	-------

- Riscaldamento elettrico (macchine elettriche) / Electrical Heating (electric machines)	12 kW	15 kW
- Consumo* (macchine elettriche) / Consumption* (electric machines)	1,5 kWh	1,6 kWh
- Assorbimento elettrico (macchine elettriche) / Electric absorption (50/60Hz) (electric machines)	14 kW	17 kW
- 3ph400V-480V(+N) / 3ph230V / 1ph230V (macchine elettriche / electric machines)	22 / 38 / 66 A	27 / 47 / 80 A
- Consumo vapore* (macchine vapore) / Steam heating consumption* (steam machines)	0,4 Kg (0.8 lb)	0,6 Kg (1.3 lb)
- Consumo elettrico* (macchine hot-water - vapore) / Electric consumption* (hot-water-steam machines)	0,8 kWh	0,9 kWh
- Assorbimento elettrico (macchine hot-water - vapore) / Electric absorption (50/60Hz) (hot-water-steam machines)	1,5 kW	1,5 kW
- 3ph400V-480V(+N) / 3ph230V / 1ph230V (macchine hot-water - vapore / hot-water-steam machines)	- / - / 4 A	- / - / 4 A

* Lavaggio "Cotone" 60° C / Cycle "Cotton" 60° C - EN60456, tab. A2

- Pos. 1 - Acqua fredda 3/4" - Press. 0,5 ÷ 10 bar \ Cold water 3/4" - Press. 0,5 ÷ 10 bar
- Pos. 2 - Acqua calda 3/4" - Press. 0,5 ÷ 10 bar \ Hot water 3/4" - Press. 0,5 ÷ 10 bar
- Pos. 3 - Entrata vapore 3/4" \ Steam inlet 3/4" Press. 0,3 ÷ 9 bar
- Pos. 4 - Scarico acqua / Drain valve Ø 50 mm (2 inch.)
- Pos. 5 - Sfiato / Air vent Ø 50 mm (2 inch.)
- Pos. 7 - Alimentazione elettrica / Electrical power supply
- Pos. 9 - Carico detersivi / Detergent load

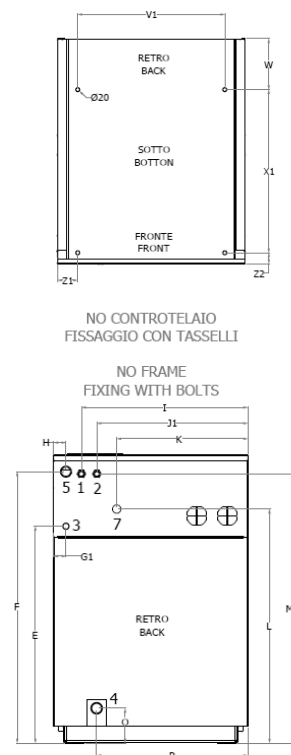
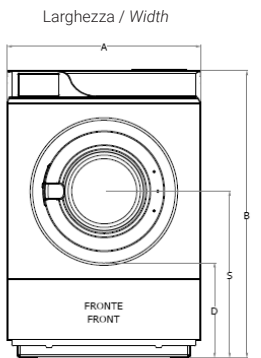
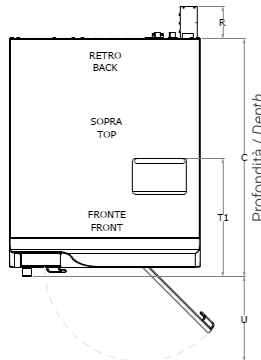
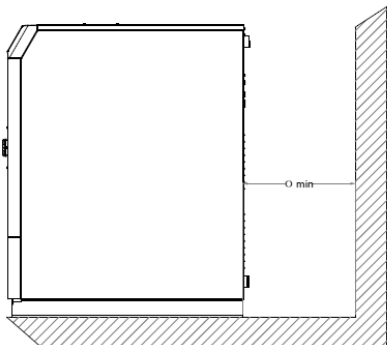

100 mm = 3.93 inch. - fattore di conversione 1 / 25,4 \ factor conversion 1 / 25,4

[mm]	A	B	C	D	E	F	G	H	I	J1	K	L	M1	O	P	Qmin	R	S	T1	U	V1	W	X1	Z1	Z2
RC 18	880	1312	1010	480	982	1230	56	56	754	684	594	1060	1220	160	685	600	150	756	545	465	690	240	675	95	51
RC 23	880	1312	1100	480	982	1230	56	56	754	684	594	1060	1220	160	685	600	150	756	545	465	690	240	765	95	51

SOLUZIONE PER IL LAVAGGIO - LINEA RC
WASHING SOLUTION - RC SERIES

LAVATRICI RIGIDE RC 30 - 40 KG
HARD MOUNTED WASHING MACHINES RC 30 - 40 KG

IM11 - UX e UI all'avanguardia
per una maggiore interazione uomo macchina.

IM11 - advanced UX and UI
for more human-machine interaction.

Efficienza perfezionata (RC 40)

Sistema di raffreddamento dell'impianto elettrico ottimizzato.

Perfected efficiency (RC 40)
Greater efficiency optimized cooling function of electrical system.

Affidabilità e manovrabilità (RC 30)

Chiusura oblo meccanica e nuova guarnizione conica.

Reliability and maneuverability (RC 30)
Mechanical door lock system and conical door gasket.

Ridotte vibrazioni (RC 30)

Guarnizione del fronte e perni di supporto oblo.

Reduced vibrations (RC 30)
Front washer gasket and door lock support pins.

Carico acqua bilanciato
Carico acqua calda e fredda bilanciato per il risparmio energetico.

Balanced water fill
Hot and cold water mixed during filling phase for energy saving.

Componentistica interna in INOX

Cesto, stella cesto e vasca in acciaio INOX AISI 304.

STAINLESS STEEL internal components
AISI 304 Stainless steel drum, spider and outer drum.

Carenatura in acciaio

Fronte, pannelli laterali e superiore in acciaio INOX AISI 304 su richiesta (RC 30).

Stainless steel structure
On request AISI 304 stainless steel front, sides and top panel (RC 30).

Sicurezza

Necessità di fissaggio a pavimento tramite controtelaio non fornito.

Security
Need of fixing to the floor with conterframe not included.

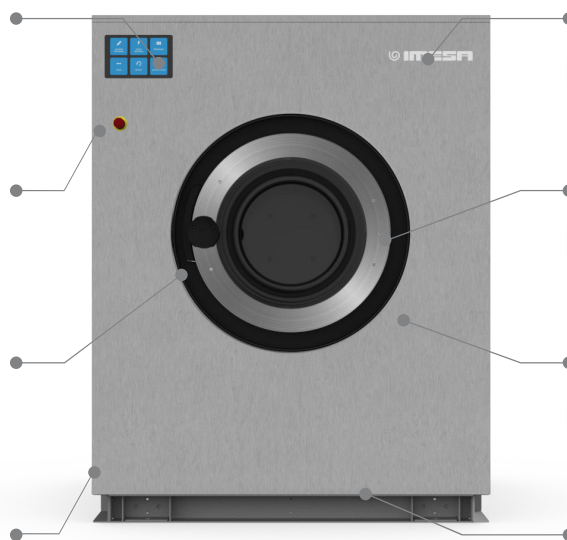

SCANSIONA PER ALTRE INFO
SCAN FOR MORE INFO



SCANSIONA PER ALTRE INFO
SCAN FOR MORE INFO

OPTIONAL e ACCESSORI / OPTIONS and ACCESSORIES

- Kit allacciamento fino a 11 pompe peristaltiche per detersivo liquido + Flush / Connection kit for up to 11 peristaltic pumps for liquid detergent + Flush
- Sistemi di dosaggio automatici detersivi da 1 a 6 pompe peristaltiche / Automatic detergent dosing systems from 1 to 6 peristaltic pumps
- Kit 2 tubi di carico acqua in rete metallica da 3/4 inch / Kit of two pieces 3/4 inch metal mesh water load pipes
- Kit controtelaio di fissaggio al suolo / Kit conterframe for ground fixing
- Fronte, top e pannelli laterali in INOX 18/10 AISI 304 (solo RC 30) / Front, top and side panels in 18/10 AISI 304 STAINLESS STEEL (RC 30 only)
- Apertura oblo sinistrorsa (solo RC 30) / Left-hand door opening (RC 30 only)
- Valvola ingresso acqua dura / Hard water inlet valve
- Seconda valvola di scarico per circuito di recupero / Second drain valve for recovery circuit
- Sistema Easy Unload (Scarico facilitato solo RC 40) / Easy Unload system (RC 40 only)
- IoT (connessione wi-fi) per controllo macchina da remoto / IoT (wi-fi connection) for remote machine control

DATI TECNICI / TECHNICAL DATA

	RC 30	RC 40
- Capacità 1:9 - 1:10 / Capacity 1:9 - 1:10	35 - 32 Kg (77 - 66 lb)	44 - 40 Kg (97 - 88 lb)
- Diametro cesto Ø / Drum diameter Ø	880 mm (34.6 inch.)	880 mm (34.6 inch.)
- Profondità cesto / Drum depth	523 mm (20.5 inch.)	645 mm (25.4 inch.)
- Volume cesto / Drum volume	320 lt	395 lt
- Diametro di carico Ø / Load diameter Ø	400 mm (15.7 inch.)	530 mm (20.8 inch.)
- Velocità di centrifuga / Spin speed	452 r.p.m.	452 r.p.m.
- Fattore G / G Factor	100	100
- Intensità sonora / Air sound intensity	65 dB (A)	65 dB (A)
- Perdite al mantello / Heating leakage	5 %	5 %
- Carico dinamico (frequenza) / Dynamic load (frequency)	6916 N (7.5 Hz)	6916 N (7.5 Hz)
- Consumo acqua fredda* / Cold water consumption**	225 l (7.9 ft³)	440 l (15.5 ft³)
- Consumo acqua calda* / Hot water consumption**	60 l (2.1 ft³)	80 l (2.8 ft³)
- Consumo acqua* / Water consumption**	285 l (10 ft³)	520 l (18.4 ft³)
- Portata scarico / Drain flow	200 lt/min (7 ft³/min)	200 lt/min (7 ft³/min)
- Dimensioni macchina: LxPxH / Machine dimension WxDxH (100 mm = 3.93 inch.)	1098x946x1433 mm	1098x1076x1400 mm
- Peso netto / Net weight	478,7 Kg (1055.3 lb)	512 Kg (1128.7 lb)
- Dimensioni imballo : LxPxH / Packing dimension WxDxH* (100 mm = 3.93 inch.)	1150x1110x1720 mm	1300x1300x1760 mm
- Peso lordo / Gross weight	531,3 Kg (1171.3 lb)	570 Kg (1256.6 lb)
- Peso lordo cassa in legno / Gross weight wooden case	-	680 Kg (1499.1 lb)
- Volume imballo / Packaging volume	2,15 mc (75.9 ft³)	2,97 mc (105 ft³)
- Macchine imballate STD per container 20' / STD. packed machines in to 20' container	10 pz.	4 pz.
- Macchine imballate STD per container 40' / STD. packed machines in to 40' container	20 pz.	9 pz.

DATI PER TIPOLOGIA DI RISCALDAMENTO / DATA BY TYPE OF HEATING

- Riscaldamento elettrico (macchine elettriche) / Electrical Heating (electric machines)	24 kW	24 kW
- Consumo* (macchine elettriche) / Consumption** (electric machines)	4 kWh	4 kWh
- Assorbimento elettrico (macchine elettriche) / Electric absorption (50/60Hz) (electric machines)	27 kW	29 kW
- 3ph400V-480V(+N) / 3ph230V / 1ph230V (macchine elettriche / electric machines)	46 / 79 / - A	49 / 85 / - A
- Consumo vapore** (macchine vapore) / Steam heating consumption** (steam machines)	0,8 Kg (1.7 lb)	1 Kg (2.2 lb)
- Consumo elettrico** (macchine hot-water - vapore) / Electric consumption** (hot-water-steam machines)	2,5 kWh	2,7 kWh
- Assorbimento elettrico (macchine hot-water - vapore) / Electric absorption (50/60Hz) (hot-water-steam machines)	4 kW	4 kW
- 3ph400V-480V(+N) / 3ph230V / 1ph230V (macchine hot-water - vapore / hot-water-steam machines)	11 / 19 / - A	12 / 20 / - A

* Le dimensioni di imballo comprendono anche il controtelaio (ove presente), imballato sopra o dietro la macchina / The packaging dimensions include the counterframe (if present), packed on top or on the back of the machine.

Il controtelaio è un accessorio ordinabile a parte / The counterframe is an accessory that can be ordered separately

- Pos. 1 - Acqua fredda 3/4" - Press. 0,5 ÷ 10 bar \ Cold water 3/4" - Press. 0,5 ÷ 10 bar
- Pos. 2 - Acqua calda 3/4" - Press. 0,5 ÷ 10 bar \ Hot water 3/4" - Press. 0,5 ÷ 10 bar
- Pos. 3 - Entrata vapore 3/4" \ Steam inlet 3/4" Press. 0,3 ÷ 9 bar
- Pos. 4 - Scarico acqua / Drain valve Ø 80 mm (3 inch.)
- Pos. 5 - Sfiato / Air vent Ø 50 mm (2 inch.)
- Pos. 7 - Alimentazione elettrica / Electrical power supply
- Pos. 9 - Carico detersivi / Detergent load

** Lavaggio "Cotone" 60° C / Cycle "Cotton" 60° C - EN60456, tab. A2

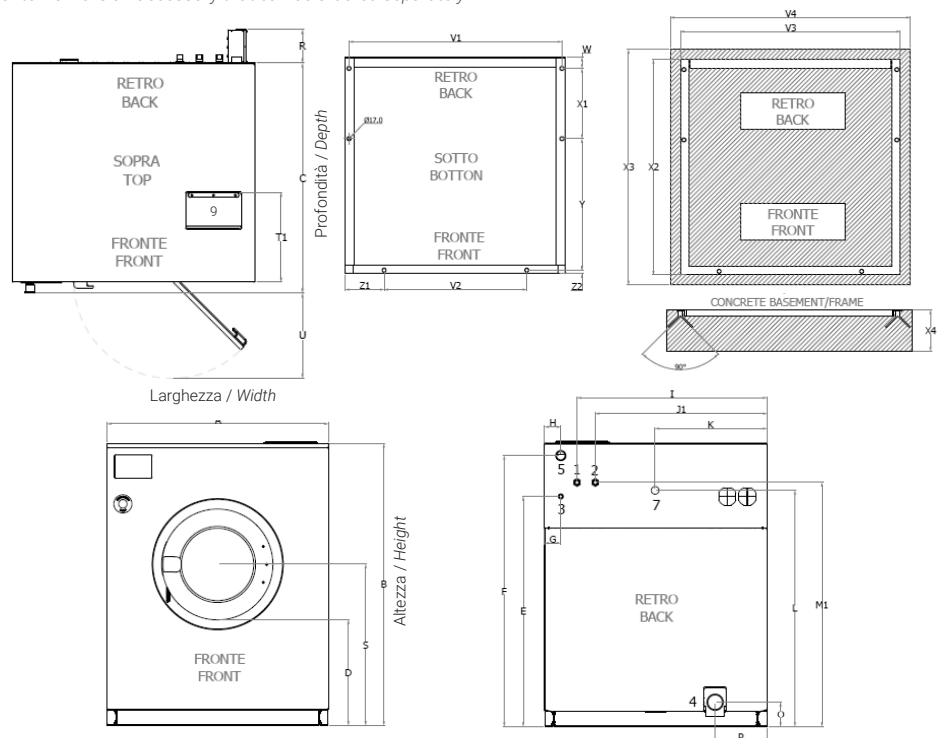

100 mm = 3.93 inch. - fattore di conversione 1 / 25,4 \ factor conversion 1 / 25,4

[mm]	A	B	C	D	E	F	G	H	I	J1	K	L	M ₁	M ₂	O	P	Q _{min}	R	S	T1	U	V1	V2	V3	V4	W	X1	X2	X3	X4	Y	Z1	Z2
RC 30	1098	1433	946	529	1169	1369	80	80	938	848	552	1165	1204	-	120	255	600	150	800	361	465	1060	800	1110	1310	205	517	972	1172	200	233	148	18
RC 40	1098	1400	1076	496	1137	1339	80	80	938	552	848	1167	1206	710	120	256	600	-	799	654	404	1060	-	1100	1310	19	350	1096	1296	200	-	-	-

SOLUZIONE PER IL LAVAGGIO - LINEA RC
WASHING SOLUTION - RC SERIES

LAVATRICI RIGIDE RC 55 - 70 - 85 KG
HARD MOUNTED WASHING MACHINES RC 55 - 70 - 85 KG

IM11 - UX e UI all'avanguardia
per una maggiore interazione uomo macchina.
IM11 - advanced UX and UI
for more human-machine interaction.

Affidabilità e manovrabilità
Nuova chiusura oblò meccanica.
Reliability and maneuverability
New mechanical door lock.

Sicurezza
Necessità di fissaggio a pavimento tramite controtelaio non fornito.
Security
Need of fixing to the floor with conterframe not included.

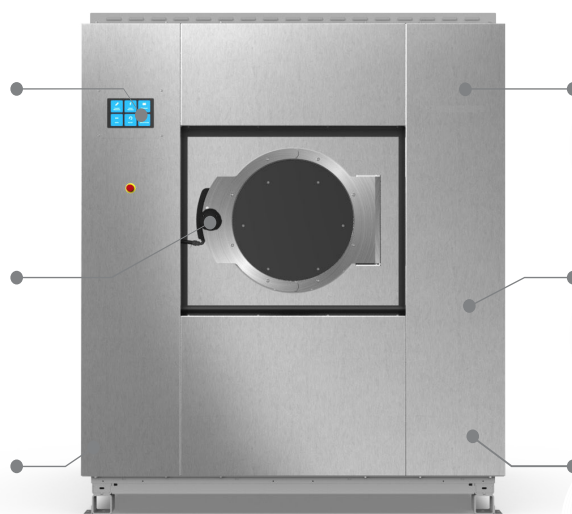

Gestione a 360°
Livello acqua, temperatura, velocità motore e ritmo rotazione/pausa programmabili.
360° management
Programmable water, temperature, engine, speed and rotation/break rate levels.

Carico acqua bilanciato
Carico acqua calda e fredda bilanciato per il risparmio energetico.
Balanced water fill
Hot and cold water mixed during filling phase for energy saving.

Struttura in acciaio INOX AISI 304
Fronte, pannelli laterali, superiore, cesto, stella cesto e vasca in acciaio INOX.
AISI 304 stainless steel structure
STAINLESS STEEL front, sides, top, drum, spider and outer drum.



SCANSIONA PER ALTRE INFO
SCAN FOR MORE INFO



SCANSIONA PER ALTRE INFO
SCAN FOR MORE INFO

OPTIONAL e ACCESSORI / OPTIONS and ACCESSORIES

- Kit allacciamento fino a 11 pompe peristaltiche per detersivo liquido + Flush / Connection kit for up to 11 peristaltic pumps for liquid detergent + Flush
- Sistemi di dosaggio automatici detersivi da 1 a 6 pompe peristaltiche / Automatic detergent dosing systems from 1 to 6 peristaltic pumps
- Kit 2 tubi di carico acqua in rete metallica da 3/4 inch / Kit of two pieces 3/4 inch metal mesh water load pipes
- Kit controtelaio di fissaggio al suolo / Kit conterframe for ground fixing
- Valvola ingresso acqua dura / Hard water inlet valve
- Seconda valvola di scarico per circuito di recupero / Second drain valve for recovery circuit
- Sistema Easy Unload / Easy Unload system
- IoT (connessione wi-fi) per controllo macchina da remoto / IoT (wi-fi connection) for remote machine control

DATI TECNICI / TECHNICAL DATA	RC 55	RC 70	RC 85
- Capacità 1:9 - 1:10 / Capacity 1:9 - 1:10	63 - 56 Kg (139-123lb)	78 - 70 Kg (172-154lb)	94 - 85 Kg (207-187 lb)
- Diametro cesto Ø / Drum diameter Ø	1080 mm (42.5 inch.)	1200 mm (47.2 inch.)	1200 mm (47.2 inch.)
- Profondità cesto / Drum depth	603 mm (23.7 inch.)	618 mm (24.3 inch.)	750 mm (29.5 inch.)
- Volume cesto / Drum volume	550 lt	700 lt	850 lt
- Diametro di carico Ø / Load diameter Ø	530 mm (20.8 inch.)	530 mm (20.8 inch.)	530 mm (20.8 inch.)
- Velocità di centrifuga / Spin speed	408 r.p.m.	360 r.p.m.	360 r.p.m.
- Fattore G / G Factor	100	86	86
- Intensità sonora / Air sound intensity	70 dB (A)	70 dB (A)	70 dB (A)
- Perdite al mantello / Heating leakage	5 %	5 %	5 %
- Carico dinamico (frequenza) / Dynamic load (frequency)	9876 N (6.8 Hz)	8527 N (6 Hz)	8357 N (6 Hz)
- Consumo acqua fredda** / Cold water consumption**	605 l (21.4 ft³)	770 l (27.2 ft³)	935 l (33 ft³)
- Consumo acqua calda** / Hot water consumption**	110 l (3.9 ft³)	140 l (4.9 ft³)	170 l (6 ft³)
- Consumo acqua** / Water consumption**	715 l (25.2 ft³)	910 l (32.1 ft³)	1105 l (39 ft³)
- Portata scarico / Drain flow	200 lt/min (7 ft³/min)	200 lt/min (7 ft³/min)	200 lt/min (7 ft³/min)
- Dimensioni macchina: LxPxH / Machine dimension WxDxH (100 mm = 3.93 inch.)	1430x1344x1870 mm	1560x1395x1870 mm	1560x1525x1870 mm
- Peso netto / Net weight	968 Kg (2133.8 lb)	1052 Kg (2319.2 lb)	1184 Kg (2610.2 lb)
- Dimensioni imballo : LxPxH / Packing dimension WxDxH* (100 mm = 3.93 inch.)	1540x1500x2020 mm	1700x1540x2020 mm	1750x1700x2020 mm
- Peso lordo / Gross weight	1051 Kg (2317 lb)	1150 Kg (2535.3 lb)	1276 Kg (2813.1 lb)
- Volume imballo / Packaging volume	4.6 mc (162.5 ft³)	5.3 mc (187.2 ft³)	5.7 mc (201.3 ft³)
- Macchine imballate STD per container 20' / STD. packed machines in to 20' container	3 pz.	3 pz.	3 pz.
- Macchine imballate STD per container 40' / STD. packed machines in to 40' container	8 pz.	7 pz.	7 pz.

DATI PER TIPOLOGIA DI RISCALDAMENTO / DATA BY TYPE OF HEATING

- Riscaldamento elettrico (macchine elettriche) / Electrical Heating (electric machines)	30 kW	30 kW	30 kW
- Consumo** (macchine elettriche) / Consumption** (electric machines)	5 kWh	9 kWh	9 kWh
- Assorbimento elettrico (macchine elettriche) / Electric absorption (50/60Hz) (electric machines)	35 kW	38 kW	40 kW
- 3ph400V-480V(+N) / 3ph230V / 1ph230V (macchine elettriche / electric machines)	56 / 96 / - A	61 / 106 / - A	65 / 113 / - A
- Consumo vapore** (macchine vapore) / Steam heating consumption** (steam machines)	1,4 Kg (3 lb)	1,8 Kg (3.9 lb)	2,2 Kg (4.8 lb)
- Consumo elettrico** (macchine hot-water - vapore) / Electric consumption** (hot-water-steam machines)	3,5 kWh	6,5 kWh	6,7 kWh
- Assorbimento elettrico risc. vapore, hot water / Electric absorption steam, hw(50/60Hz)	5 kW	9 kW	9 kW
- 3ph400V-480V(+N) / 3ph230V / 1ph230V (macchine hot-water - vapore / hot-water-steam machines)	14 / 24 / - A	18 / 31 / - A	22 / 37 / - A

* Le dimensioni di imballo comprendono anche il controltelaio (ove presente), imballato sopra o dietro la macchina / The packaging dimensions include the counterframe (if present), packed on top or on the back of the machine.

Il controltelaio è un accessorio ordinabile a parte / The counterframe is an accessory that can be ordered separately

- Pos. 1 - Acqua fredda 1 1/2" - Press. 0,5 ÷ 10 bar
Cold water 1 1/2" - Press. 0,5 ÷ 10 bar
- Pos. 2 - Acqua calda 1 1/2" - Press. 0,5 ÷ 10 bar
Hot water 1 1/2" - Press. 0,5 ÷ 10 bar
- Pos. 3 - Entrata vapore 3/4" \
Steam inlet 3/4" Press. 0,3 ÷ 9 bar
- Pos. 4 - Scarico acqua /
Drain valve Ø 80 mm (3 inch.)
- Pos. 5 - Sfiato / Air vent Ø 80 mm (3 inch.)
- Pos. 7 - Alimentazione elettrica /
Electrical power supply
- Pos. 9 - Carico detersivi / Detergent load

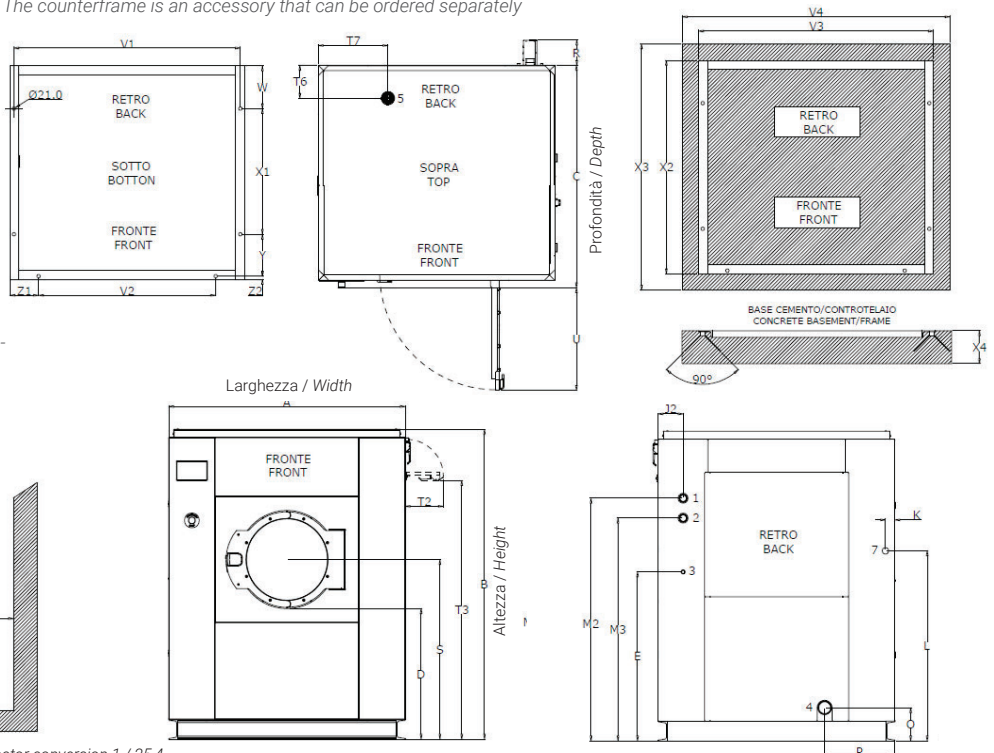

** Lavaggio "Cotone" 60° C / Cycle "Cotton" 60° C - EN60456, tab. A2

100 mm = 3.93 inch. - fattore di conversione 1 / 25,4 \ factor conversion 1 / 25,4

[mm]	A	B	C	D	E	J2	K	L	M2	M3	O	P	Q _{min}	R	S	T2	T3	T4	T5	T6	T7	U	V1	V2	V3	V4	W	X1	X2	X3	X4	Y	Z1	Z2
RC 55	1430	1870	1344	788	1020	150	57	1148	1465	1345	200	425	600	150	1084	230	1560	155	630	200	421	623	1380	1080	1430	1630	260	765	1300	1500	200	255	175	20
RC 70	1560	1870	1395	830	1020	150	57	1148	1465	1345	200	490	600	150	1118	230	1560	155	630	513	310	623	1520	1200	1560	1760	260	765	1350	1550	200	305	180	20
RC 85	1560	1870	1525	830	1020	150	57	1148	1465	1345	200	490	600	150	1118	230	1560	155	630	579	310	623	1520	1200	1560	1760	260	897	1482	1582	200	305	180	20

C200101X.07 - 10/08/2023 - I dati tecnici e caratteristiche possono essere soggette a variazioni / Specification and technical data are subject to